

DH-SD1A204DB-GNY

2MP 4x Starlight IR WizSense Network PTZ Camera



Launched by Dahua Technology, WizSense is a series of AI products and solutions that adopt independent AI chip and deep learning algorithm. It focuses on human and vehicle with high accuracy, enabling users to fast act on defined targets. Based on Dahua's advanced technologies, WizSense provides intelligent, simple and inclusive products and solutions.

System Overview

With its powerful optical zoom, and accurate pan and tilt capabilities, this series of cameras provides an all-in-one solution for large-scale monitoring. It displays images in 2 MP resolution at 25 fps and 30 fps. These cameras offer smooth control and high-grade protection that enable them to meet the requirements of video surveillance in small-sized scenes.

Functions

Starlight Technology

With advanced image processing technology and optical technology, Dahua Starlight technology can provide clear colorful video in the environment of low illuminance. It widely applies to various environments of low illuminance.

Wide Dynamic Range

The camera produces vivid images, even in high-contrast lighting conditions, by using industry-leading wide dynamic range (WDR) technology. For scenes that quickly alternate between bright and low lighting, WDR adjusts to fully capture both the bright and dark areas of a scene, producing superior quality videos.

- 1/2.8" 2Megapixel CMOS.
- 4x optical zoom.
- Starlight technology.
- Max. 25/30 fps@2MP.
- IR distance up to 20 m.
- Perimeter protection.
- Face detection.
- SMD 3.0.
- Built-in Mic.
- IP66; IK08.



H265+

H.265+ is the optimized implementation of the H.265 codec that uses a scene-adaptive encoding strategy, dynamic GOP, dynamic ROI, flexible multi-frame reference structure and intelligent noise reduction to deliver high-quality videos without placing strain on the network. H.265+ technology reduces bit rate and storage requirements by up to 70% when compared to standard H.265 video compression.

SMD3.0

Empowered by deep-learning algorithms, Dahua SMD filters out motion detection alarms triggered by targets that are not a concern. It quickly recognizes humans and vehicles, triggering alarms when an intrusion occurs.

Perimeter Protection

Automatically filters out false alarms caused by animals, rustling leaves, bright lights, and more, and uses secondary recognition during target detection to improve alarm accuracy.

Protection (IP66, TVS 6000 V)

IP66, TVS 6000 V lightning proof, surge protection, and voltage transient protection.

Technical Specification

Camera

Image Sensor	1/2.8" CMOS
Pixel	2 MP
Max. Resolution	1920 (H) × 1080 (V)
ROM	256 MB
RAM	512 MB
Electronic Shutter Speed	1 s–1/30,000 s
Scanning System	Progressive
Min. Illumination	0.005 lux@F1.8 (Color, 30 IRE); 0.0005 lux@F1.8 (B/W, 30 IRE); 0 lux (illuminator on)
Illumination Distance	20 m (65.62 ft) (IR)
Illuminator On/Off Control	Manual; SmartIR; Off
Illuminator Number	3 (IR light)

Lens

Focal Length	2.8 mm–12 mm			
Max. Aperture	F1.8–F2.7			
Field of View	H: 101.6°–51.9°; V: 53.1°–29.1°; D: 121.8°–59.7°			
Optical Zoom	4x			
Focus Control	Auto; semi-auto; manual			
Close Focus Distance	0.2 m–0.5 m (0.66 ft– 1.64 ft)			
Iris Control	Fixed iris			
DORI Distance	Detect	Observe	Recognize	Identify
	165.5 m (542.98 ft)	65.4 m (214.57 ft)	33.1 m (108.60 ft)	16.6 m (54.46 ft)

PTZ

Pan/Tilt Range	Pan: 0° to 355°; Tilt: 5° to 90°
Manual Control Speed	Pan: 0.1°/s–70°/s; Tilt: 0.1°/s–30°/s
Preset Speed	Pan: 0.1°/s–80°/s; Tilt: 0.1°/s–40°/s
Preset	300
Tour	8 (up to 32 presets per tour)
Power-off Memory	Yes
Idle Motion	Preset; Tour
PTZ Protocol	DH-SD

Intelligence

IVS (Perimeter Protection)	Tripwire; intrusion; crossing fence detection; loitering detection; abandoned/missing object; fast moving; parking detection; people gathering; human alarm classification
Face Detection	Supports face detection, snapshot, and face enhancement; Supports face cutout: Face, one-inch photo; Capturing strategies include real-time capturing and quality first.

People Counting	Supports counting the number of people that cross the detection line, counting the number of people in an area and queue management. Also, only people counting that cross the detection line supports the report function.
SMD	Yes

Video

Video Compression	H.264H; H.264B; Smart H.265+; H.264; H.265; MJPEG (Sub Stream); Smart H.264+
Streaming Capability	3 streams
Resolution	1080p (1920 × 1080); 1.3M (1280 × 960); 720p (1280 × 720); D1 (704 × 576/704 × 480); VGA (640 × 480); CIF (352 × 288/352 × 240)
Video Frame Rate	Main stream: 1080p/1.3M/720p@(1-25/30 fps) Sub stream 1: D1/VGA/CIF@(1-25/30 fps) Sub stream 2: 1080p/1.3M/720p@(1-25/30 fps)
Bit Rate Control	CBR/VBR
Video Bit Rate	H264: 96 Kbps–14,848 Kbps H265: 38 Kbps–8,960 Kbps
Day/Night	ICR: Color; B/W; Auto; Electronic: Color; B/W; Auto
BLC	Yes
WDR	120 dB
HLC	Yes
White Balance	Auto; indoor; outdoor; tracking; manual; sodium lamp; natural light; street lamp
Gain Control	Auto; manual; gain prio
Noise Reduction	2D NR; 3D NR
Motion Detection	Yes
Region of Interest (RoI)	Yes
Image Stabilization	Electronic Image Stabilization (EIS)
Defog	Electronic
Digital Zoom	16x
Image Rotation	180°
S/N Ratio	≥55 dB

Audio

Audio Compression	PCM; G.711A; G.711MU; G.726; MPEG2-Layer2; G.722.1
-------------------	--

Network

Network Port	RJ-45 (10/100 Base-T)
Network Protocol	FTP; RTMP; IPv6; Bonjour; IPv4; DNS; RTCP; PPPoE; NTP; RTP; 802.1x; HTTPS; SNMP; TCP/IP; DDNS; UPnP; NFS; ICMP; UDP; IGMP; HTTP; SSL; DHCP; SMTP; Qos; RTSP; ARP
Interoperability	ONVIF (Profile S & Profile G & Profile T); CGI; SDK
User/Host	20 (total bandwidth: 64 M)
Storage	Micro SD card (512 GB); FTP/SFTP; NAS
Browser	IE 9 and later versions; Chrome 41 and later versions; Firefox 50 and later versions; Safari 10 and later versions

Management Software	DMSS; DSS Pro
Mobile Client	iOS; Android
Certification	
Certifications	CE-EMC: EN 55032; EN 61000-3-3; EN 61000-3-2; EN 50130-4; EN 55035 CE-LVD: EN 62368-1 FCC: 47 CFR FCC Part15, Subpart B, NSI C63.4
Port	
Audio Input	1 channel (LINE IN, bare wire)
Audio Output	1 channel (LINE OUT, bare wire)
Alarm Linkage	Capture; recording; send email; preset; tour
Alarm Event	Motion/tampering detection; audio detection; network disconnection detection; IP conflict detection; memory card state detection; memory space detection
Audio I/O	1/1
Power	
Power Supply	12 VDC, 2 A ± 10%; PoE (802.3af)
Power Consumption	Basic: 4 W; Max: 13 W (illuminator on)
Environment	
Operating Temperature	-30 °C to +60 °C (-22 °F to +140 °F)
Operating Humidity	≤95%
Protection	TVS 6000 V lightning proof; IP66; IK08; surge protection; voltage transient protection
Structure	
Product Dimensions	65.4 mm × Φ128.0 mm (2.57" × 5.04")
Net Weight	0.5 kg (1.10 lb)
Gross Weight	0.7 kg (1.54 lb)

Ordering Information

Type	Model	Description
2MP WizSense PTZ Camera	DH-SD1A204DB-GNY	2M 4x Starlight IR WizSense Network PTZ Camera
	SD1A204DB-GNY	2M 4x Starlight IR WizSense Network PTZ Camera
Accessories (Optional)	DC12V/2.0A	Power Adapter
	PFA107	Mount Adapter
	PFB305W	Wall Mount Bracket
	PFA120	Junction Box
	PFA140	Power Box
	PFA151	Corner Mount Bracket
	PFB220C	Ceiling Mount Bracket
	PFA150	Pole Mount Bracket

Accessories

Optional:



DC12V/2.0A Power Adapter



PFA107 Mount Adapter



PFB305W Wall Mount Bracket



PFA120 Junction Box



PFA140 Corner Mount Bracket





PFA151 Corner Mount Bracket



PFB220C Ceiling Mount Bracket

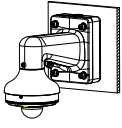
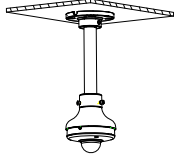

PFA150 Pole Mount Bracket

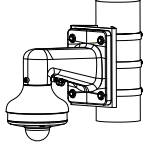
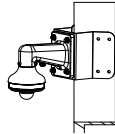
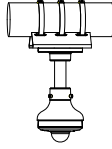
Wall Mount	Ceiling Mount	Ceiling Mount
PFB305W+PFA107+PFA120	PFA107+PFB220C	\
		
Pole Mount(Vertical)	Corner Mount	Pole Mount(Horizontal)
PFA107+PFB305W+PFA150	PFA107+PFB305W+PFA151	PFA107+PFB220C+PFA150
		

Dimensions (mm[inch])

